

# Edger “White Dev Board r2” - Assembly Instructions rev. 1.03 11/19/2022

## Section 1 - Parts

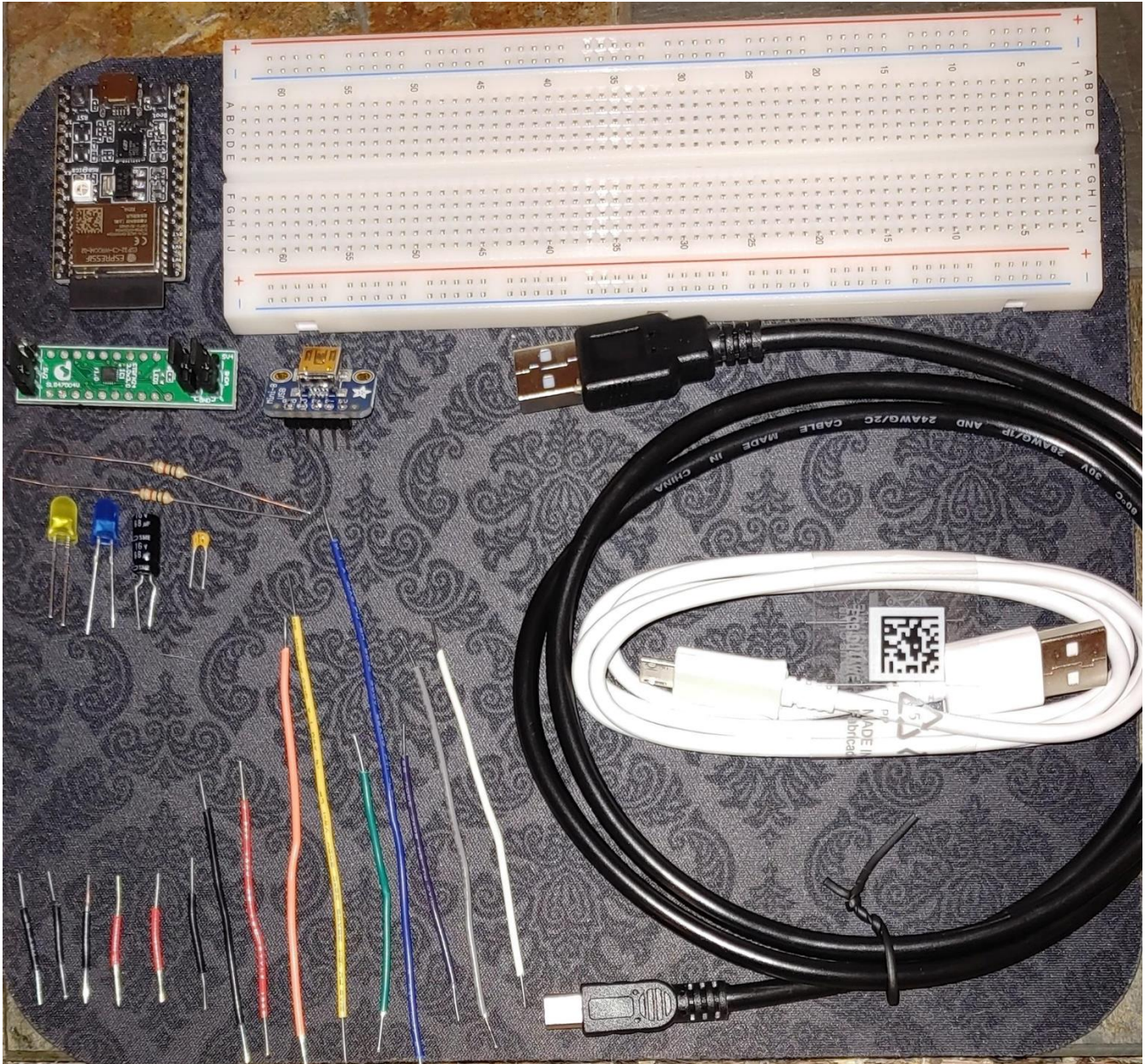

It is suggested that you read through all of the instructions before placing parts on your board. Examine all the photos to understand part orientation.

**Parts list:**

Color	Length (cm)	Count
Blk	2.5	3
Blk	3.0	1
Blk	5.8	1
Red	2.5	2
Red	5.8	1
Org	8.7	1
Ylw	9.3	1
Grn	8.3	1
Blu	11.5	1
Vio	5.9	1
Gry	8.3	1
Wht	7.7	1

Component	Count	Notes
100nF yellow capacitor	1	Orientation of the two wire leads does not matter.
68uF Blk cannister capacitor	1	"- lead" MUST be connected to blue Ground Rail: safety issue. Double check before powering up the board.
Yellow LED	1	Longer wire lead is "+ anode", shorter "- cathode"
Blue LED	1	Longer wire lead is "+ anode", shorter "- cathode"
1000 ohm resistor	2	Orientation of the two wire leads does not matter.
miniUSB connector	1	Adafruit 1764
ESP32C3 dev board	1	Espressif ESP32C3-DevKit-02
SLG47004V-DIP FPGA	1	Renesas ForgeFPGA
USB A to Mini-B cable	1	1 meter
USB A to Micro-B cable	1	1 meter

It's **important** that the black cannister capacitor and the two LEDs are inserted as described in the Notes column of the table above.

## Section 2 - Completed board for reference

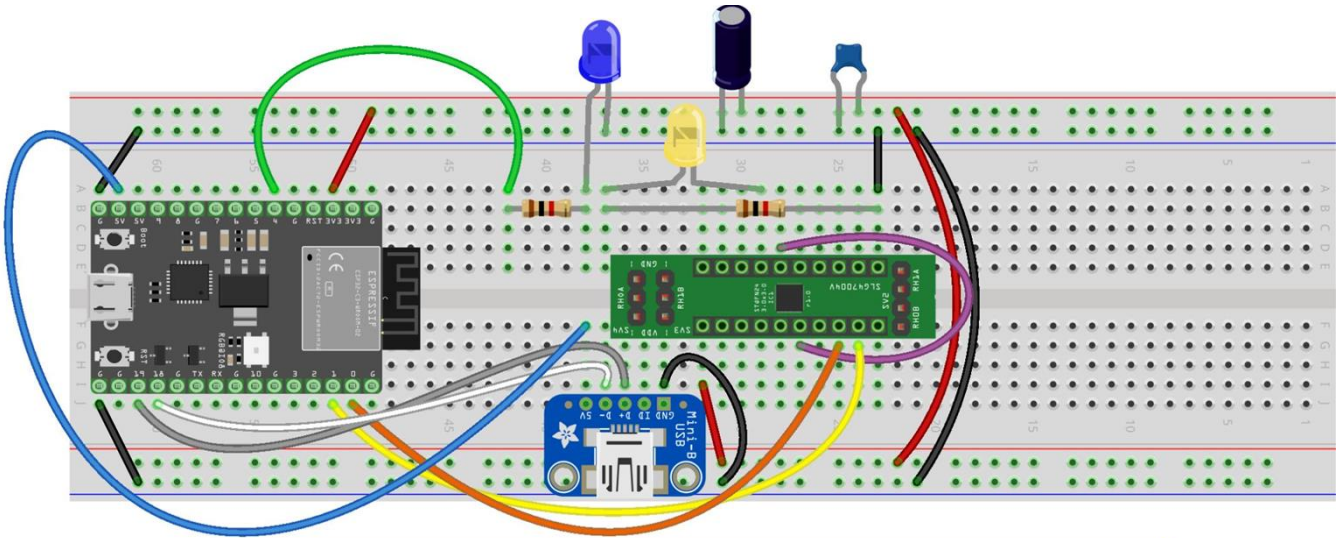

Note: some of the wire lengths have been exaggerated in this image to make all connection points visible.

When wiring an actual board, some wires may need to run under the edges of the components. This allows for easy removal of individual components without the need to disturb the wiring.

See the photos of the wired board for clarification.

fritzing

Note: the small blue capacitor on the top right of the breadboard diagram, above, is actually yellow in this parts kit. See the photo below. The two are the same for our purposes.

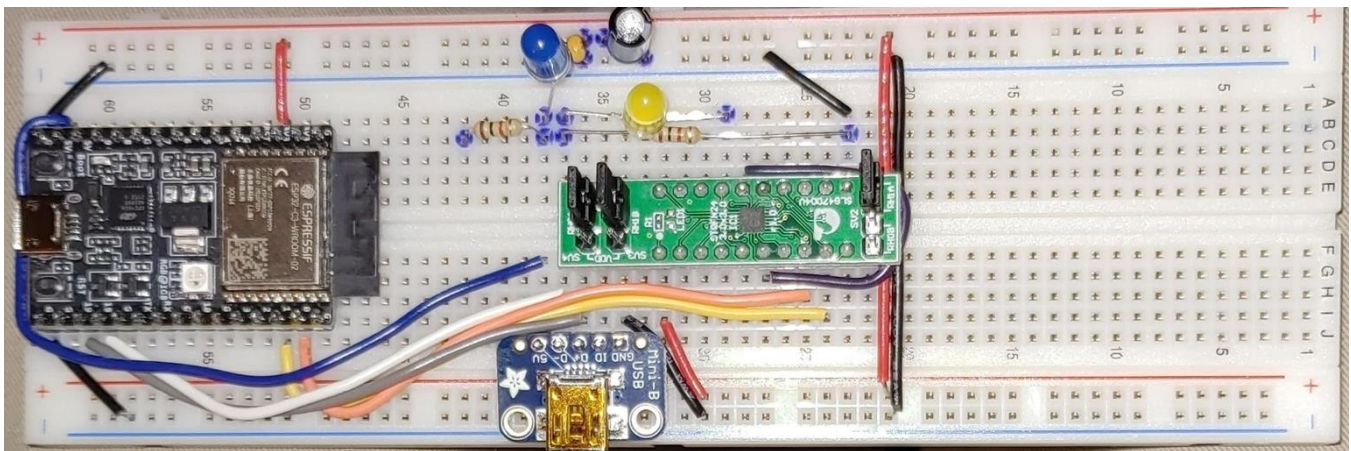

### Section 3 - Parts placement

#### Step 1 – Devices (development boards)

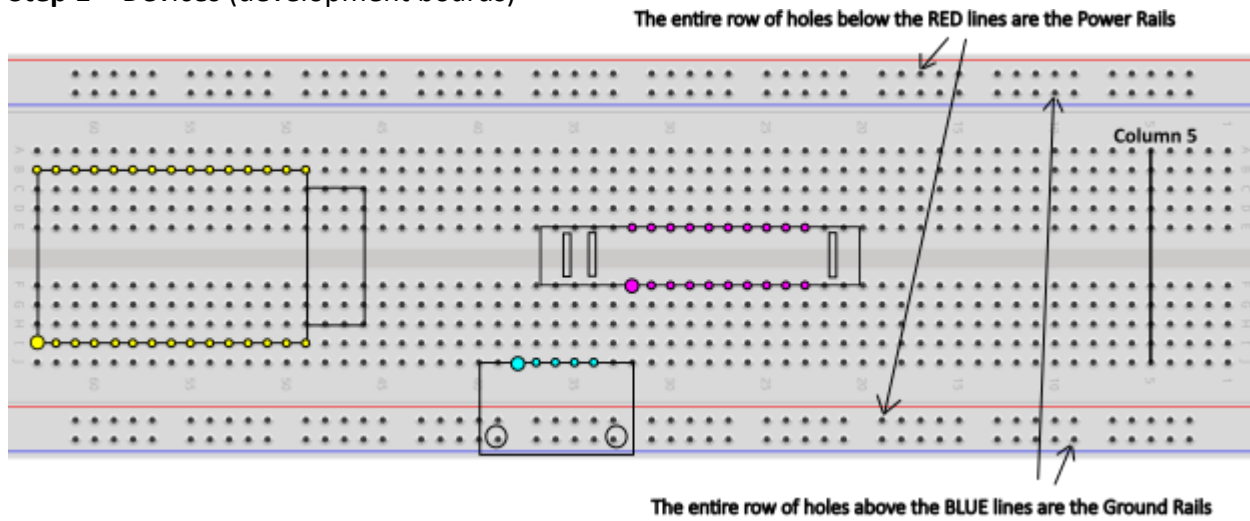

#### Device Placement:

- The outlines on the breadboard above show where the 3 devices should be placed.
- The dots indicate where the pins on the bottom of the device should be pushed (gently) into the breadboard holes.
- The larger dots correspond to the information given in the Parts Placement Table (see below).

#### Pin Numbers:

- The Pin numbers for each device start with the large dot on the diagram.
- The large dot is Pin 1. Pin numbers increase as you move to the right.
- Pin numbers in the top row of a device continue from right to left.
- These Pin numbers are used in the Wiring Table, in Step 3.

#### Breadboard Notes:

- The two Power Rails and two Ground Rails are labelled above.
- The board has 63 columns. The five holes in the top half of any given column are electrically connected. This means that they can be used interchangeably.
- The same is also true for the five holes in the bottom of any given column.
- The top five holes and the bottom five holes in a given column are NOT connected to each other.

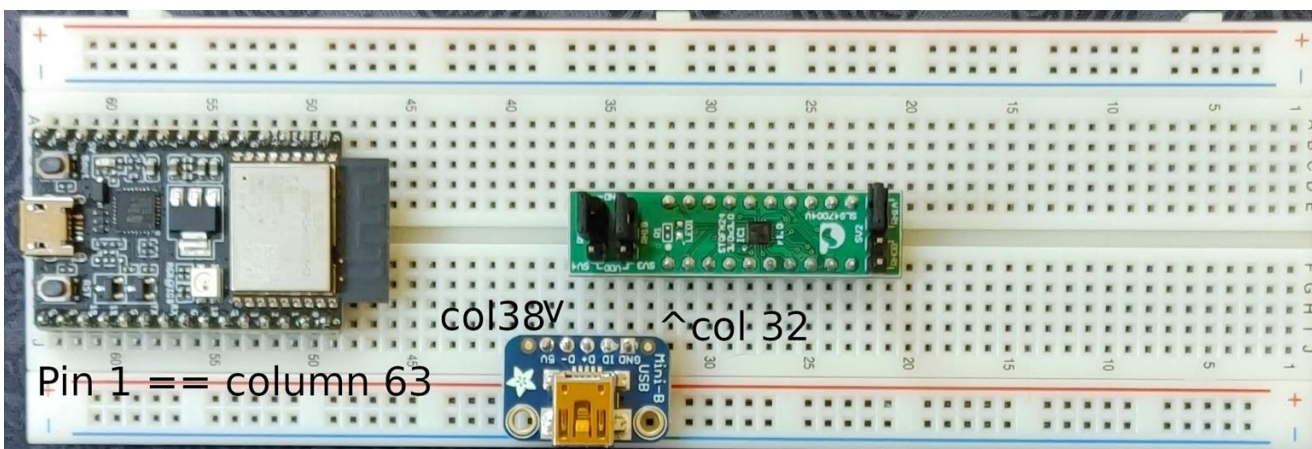

Shown here are the devices and the breadboard column position of their leftmost pin.

## Step2 – Small components

### Yellow LED

The leads of the yellow LED are a little too thin to be held tightly by the solderless breadboard. Here's a workaround: the bottom of the leads should be bent in a zig-zag shape to cause their effective width to be larger.

Here is a picture of one of the leads bent to fit into the solderless breadboard firmly. The shadow shows the bends at the bottom of the lead clearly.



The long lead of the yellow LED (anode) is extended to the right and positioned in Column 29 in the photo below.

### Resistors

The lead of the long resistor running alongside the green FPGA needs to be trimmed on one end. One method:

- Make a 90 degree bend on one resistor lead, approx. 8mm from the bottom of the lead. Place this end of the resistor into the hole in Column 23, then bend the longer part of the lead to the left, as shown below.
- Trim the left resistor lead so that it is approximately 2 ½ holes beyond Column 37 (where it will eventually be pushed into a breadboard hole.)
- The end of the left resistor lead is then bent down and pushed into position.

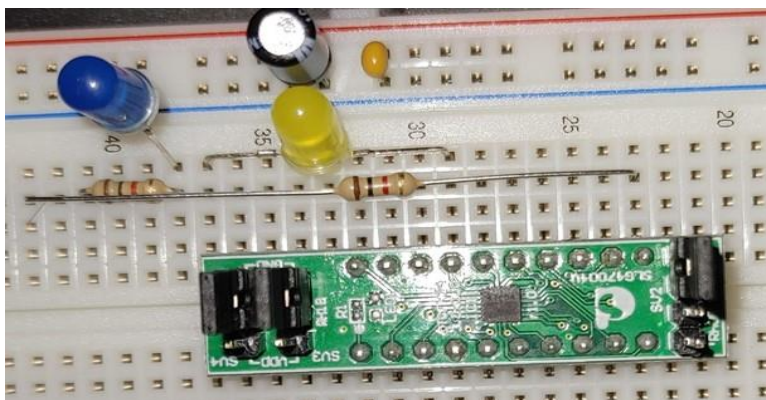

### Blue LED

The longer blue LED lead (anode) is positioned in column 38. The shorter lead (cathode) is positioned in a Ground Rail hole. All Ground Rail holes are electrically identical, so exactly which hole the lead is placed in is simply chosen for convenience.

## Black Cannister Capacitor

### The orientation of the capacitor leads is Very Important!

The cannister of the capacitor has a light gray stripe running down one side. The lead at the bottom of this stripe should be placed into the Ground Rail. The other lead should be placed into the Power Rail.

## Yellow capacitor

The orientation of the small yellow capacitor is not important. It works in either direction. Place one lead into a hole on the Ground Rail and the other into a hole on the Power Rail.

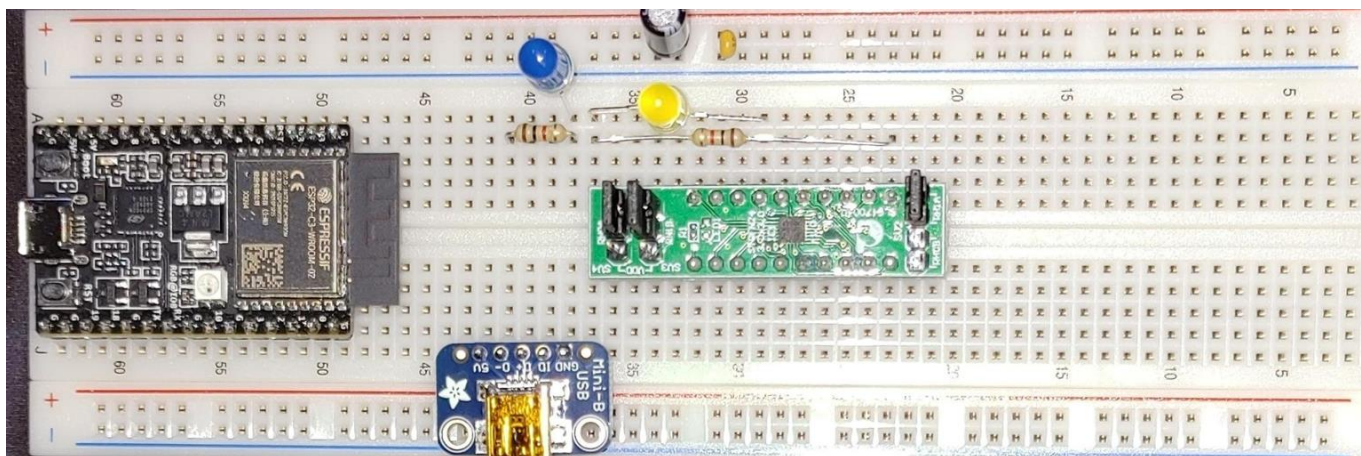

This photo shows all of the components placed on the board.

## Steps 1 & 2: Parts Placement Table

Device	<u>Breadboard</u> column # of leftmost device pin	<u>Device</u> pin number/name
Espressif ESP32-C3-DEVKITC-02	63	1
Adafruit 1764 JTAG USB breakout	38	"5V"
Renesas ForgeFPGA SLG47004V-DIP	32	1
Component (directional)	Breadboard column #	Device lead name
Blue LED	38	Anode (long lead)
	Ground Rail	Cathode (short lead)
Yellow LED	29	Anode (long lead)
	37	Cathode (short lead)
Black Cannister capacitor (See important note in the Cannister capacitor section, above)	Ground Rail	- lead, denoted by grey stripe on cannister
	Power Rail	+ lead
Component (non-directional)	Breadboard column #	Breadboard column #
1k resistor (#1)	38	42
1K resistor (#2)	37	23
Yellow capacitor	Ground Rail	Power Rail

### Step 3: Wiring Placement Table

- Referring to the completed breadboards in Section 2, notice how wires are run away from the Espressif and FPGA boards, so the unused breadboard positions can be accessed later with jumper wires.
- The depth of the breadboard holes is approx. 8mm.
- In order to get a good connection:
  - bend approximately 8mm of the exposed wire at each end of the cut wire lengths
  - bend at approx. 90 degrees to the insulated part of the wire
  - As a measurement guide, the distance between 2 ½ holes on the surface of the breadboard is roughly 8mm
- The table below shows the rough order in which wires should be placed on the breadboard. The order is designed to simplify the placement of later wires.
- Referring to the completed breadboards in Section 2 will simplify your task.
- The small images on the next page may also be useful.

Wire Color	Length (cm)	From: Device / Pin # / "Device label"	To: Device / Pin # / "Device label"	Notes
Blk	2.5	ESP / Pin 30 / "G"	BB / Ground Rail (blue line)	
Red	2.5	ESP / Pin 18 / "3.3V"	BB / Power Rail (red line)	
Blk	2.5	ESP / Pin 1 / "G"	BB / Ground Rail (blue line)	
Blk	2.5	FPGA / Pin 11 / "GND"	BB / Ground Rail (blue line)	
Red	2.5	FPGA / pin 1 / "VDD"	BB / Power Rail (red line)	
Red	5.8	BB / Power Rail 1 (red line)	BB / Power Rail 2 (red line)	Wire runs under end of FPGA
Blk	5.8	BB / Ground Rail 1 (blue line)	BB / Ground Rail 2 (blue line)	Wire runs under end of FPGA
Grn	6.3	ESP / Pin 21 / "4"	BB / Column 42	
Blk	3.0	JTAG USB / Pin 5 / "GND"	BB / Ground Rail (blue line)	
Org	8.7	FPGA / Pin 8 / "SCL"	ESP / Pin 14 / "0"	
Ylw	9.5	FPGA / Pin 9 / "SDA"	ESP / Pin 13 / "1"	
Vio	5.9	FPGA / Pin 6 / "GPIO 15"	FPGA / Pin 16 / "GPIO 16"	Wire runs under the FPGA
Wht	7.7	ESP / Pin 4 / "18"	JTAG USB / Pin 2 / "D-"	
Gry	8.3	ESP / Pin 5 / "19"	JTAG USB / Pin 3 / "D+"	
Blu	11.5	ESP / Pin 29 / "5V"	JTAG USB / Pin 1 / "5V"	Wire runs around the ESP

Note: the small 'v's on the photos are intended to be arrows

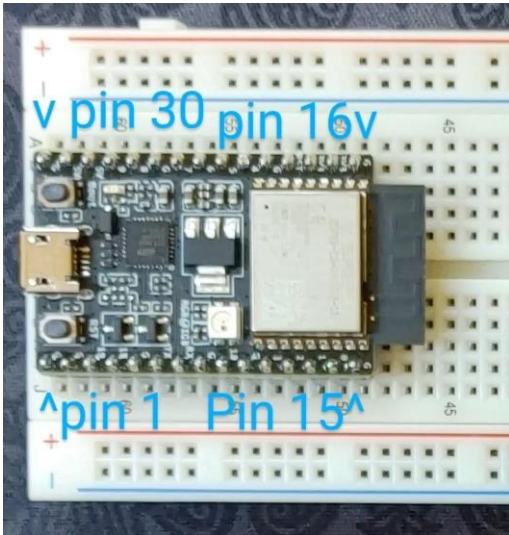

Espressif ESP32-C3-DEVKITC-02 board

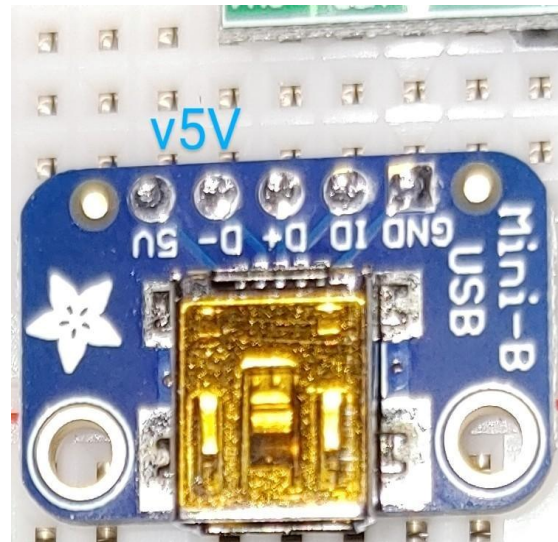

Adafruit 1764 USB Breakout board

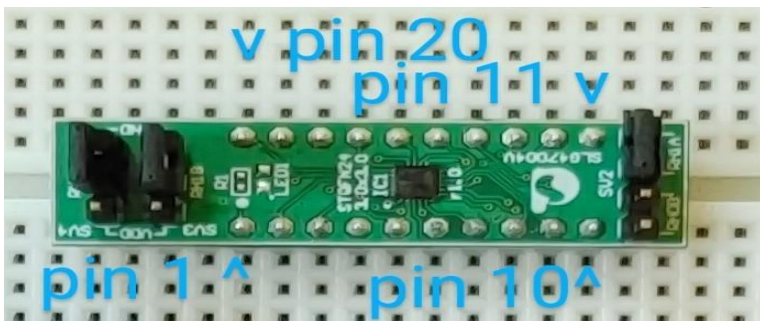

Renesas ForgeFPGA SLG47004V-DIP

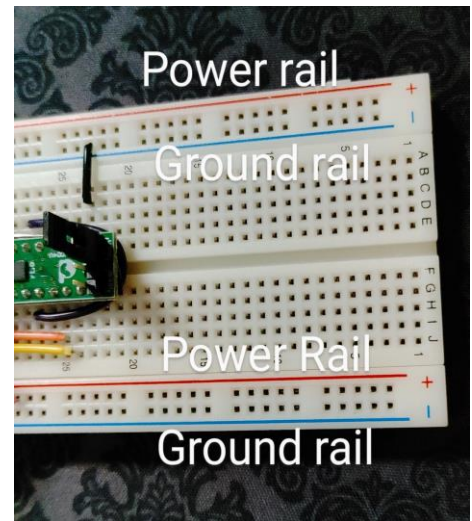

Solderless breadboard